

Section 4

This section is separated into two parts as follows.



Section 4a **ORIGINALS**

Key Blanks with the authorized Original Manufacturer's logos and/or designs.



Section 4b **LOOK ALIKE®**

Key Blanks manufactured to look just like the Original Manufacturer's key, without the brand name.

Look Alike Key Number	Ilco Equivalent	Ilco EZ Equivalent	Fits	Finish	Look Alike Key Number	Ilco Equivalent	Ilco EZ Equivalent	Fits	Finish
320560	1970AM	RA4	American Motors	NP	1063KW-BR-250PK	1176	KW1	Kwikset	BR
320561	S1970AM	RA3	American Motors	NP	1063KW-NP-250PK	1176	KW1	Kwikset	NP
PTKB1	1045	AM3	American	BR	N1063KW	1176	KW1	Kwikset	NP
CH1C	B1179-1C	-	Arrow	NS	B308	1004	L1	Lockwood	NP
CH1D	B1179-1D	-	Arrow	NS	B310	1004A	L4	Lockwood	NP
K2-A	1179	AR1	Arrow	BR	15K	1092N	M16	Master	BR
K7	1179A	AR4	Arrow	NS	1K	1092	M16	Master	BR
1A1A1	A1114A	BE2	Best	NS	1515	-	-	Medeco	NS
1A1B1	A1114B	-	Best	NS	1517	-	-	Medeco	NS
1A1C1	A1114C	-	Best	NS	1518	-	-	Medeco	NS
1A1D1	A1114D	-	Best	NS	1542	-	-	Medeco	NS
1A1DD1	A1114DD	-	Best	NS	1543	-	-	Medeco	NS
1A1E1	A1114E	-	Best	NS	1638	-	-	Medeco	NP
1A1F1	A1114F	-	Best	NS	1644	-	-	Medeco	NP
1A1FM1	A1114FM	-	Best	NS	1655	-	-	Medeco	NS
1A1G1	A1114G	-	Best	NS	A1515	-	-	Medeco	NS
1A1H1	A1114H	-	Best	NS	A1517	-	-	Medeco	NS
1A1J1	A1114J	-	Best	NS	A1638	-	-	Medeco	NP
1A1K1	A1114K	-	Best	NS	4295	R1064E	NA25	National	BR
1A1L1	A1114L	-	Best	NS	5981R	N1011P	RU52	Russwin	NS
1A1M1	A1114M	-	Best	NS	5D1R	1011D1	RU45	Russwin	NS
1A1Q1	A1114Q	-	Best	NS	6D1R	A1011D1	RU46	Russwin	NS
1A1R1	A1114R	-	Best	NS	275LA	1007LA	S22 1/2	Sargent	NS
1A1TA1	-	-	Best	NS	275S	1010N	S68	Sargent	NS
1A1TB1	A1114TB	-	Best	NS	6275LA-NP	01007LA	S22	Sargent	NP
1A1WA1	-	-	Best	NS	6275LA-NS	01007LA	S22	Sargent	NS
1A1WB1	-	-	Best	NS	100-C	1145	SC1	Schlage	NP
1A1WC1	-	-	Best	NS	100-C-250PK	1145	SC1	Schlage	NP
1A1WD1	-	-	Best	NS	100C-BR	1145	SC1	Schlage	BR
1A1WE1	-	-	Best	NS	100-C-NS	1145	SC1	Schlage	NS
1A1WG1	-	-	Best	NS	100C-NS 250PK	1145	SC1	Schlage	NS
1A1WH1	-	-	Best	NS	100-E	1145E	SC8	Schlage	NP
1A1WY1	-	-	Best	NS	100-E-NS	1145E	SC8	Schlage	NS
K4	1041G	CG1	Chicago	BR	101-C	1145A	SC4	Schlage	NP
K5	C1041P	-	Chicago	BR	101C-BR	1145A	SC4	Schlage	BR
320433	S1768CH	-	Chrysler	NP	101C-BR-250PK	1145A	SC4	Schlage	BR
320514	1769CH	-	Chrysler	NP	101-CE-NS	A1145CE	-	Schlage	NS
Z1-59A1-6	A1001AH	CO91	Corbin	NS	101-C-NS	1145A	SC4	Schlage	NS
Z1-59A2-6	A1001FH	CO92	Corbin	NS	101C-NS 250PK	1145A	SC4	Schlage	NS
Z1-59B1-6	A1001BH	CO94	Corbin	NS	101-E	A1145E	SC9	Schlage	NP
Z1-59B2-6	A1001DH	CO95	Corbin	NS	101-EF-NS	A1145EF	-	Schlage	NS
Z1-59C1-6	A1001C1	CO98	Corbin	NS	101-E-NS	A1145E	SC9	Schlage	NS
Z1-59C2-6	A1001C2	CO102	Corbin	NS	101E-NS 250PK	A1145E	SC9	Schlage	NS
Z1-59D1-6	A1001D1	CO107	Corbin	NS	101-F	A1145F	SC10	Schlage	NP
Z1-59D2-6	A1001D2	CO108	Corbin	NS	101-F-NS	A1145F	SC10	Schlage	NS
Z1-60-5	1001EH	CO87	Corbin	NS	180A	1307A	SC6	Schlage	NP
Z1-60-6	A1001EH	CO88	Corbin	NS	200W	1307W	SC22	Schlage	NP
67	D1054K	DE6	Dexter	BR	K9	1120D	SL1	Segal	BR
S54F	-	-	Dominion	NP	83559	A1176ST	KW10	Titan	NP
KB1577G	A1054WD	FA3	Falcon	NS	08260KW	A1176ST	KW10	Titan	NS
P1577E	A1054WC	FA2	Falcon	NS	07743	-	-	Titan (Lg. Head)	NP
00113	1167FD	H51	Ford	NP	13D	VR91AR	VR7	Viro	NP
00114	S1167FD	H50	Ford	NP	15D	VR91AR	VR2	Viro	NP
00116	1184FD	H54	Ford	NP	1555	1054WB	WR3	Weiser	NP
GM-A	P1098A	B48	GM	NP	1555-NP-250PK	1054WB	WR3	Weiser	NP
GM-B	S1098B	B49	GM	NP	1555-NS	1054WB	WR3	Weiser	NS
GM-C	P1098C	B50	GM	NP	P1555	N1054WB	WR5	Weiser	NP
GM-D	S1098D	B51	GM	NP	P1555-BR-250PK	N1054WB	WR5	Weiser	BR
GM-E	P1098E	B44	GM	NP	P1555-NS	N1054WB	WR5	Weiser	NS
GM-H	S1098H	B45	GM	NP	12344	1175N	WK2	Weslock	BR
GM-J	P1098J	B46	GM	NP	12344-NS	1175N	WK2	Weslock	NS
GM-K	S1098K	B47	GM	NP	8	999	Y1	Yale	BR
HARLOC	X1014F	EA27	Harloc	BR	9114	01122	Y11	Yale	BR
H20	1003M	CO106	Hudson	BR	9278	01122A	Y12	Yale	BR
H21	R1003M	BO1	Hudson	BR	8 YALE-250PK	999	Y1	Yale	BR
1063KW	1176	KW1	Kwikset	NP	E8	999N	Y1E	Yale	BR
1063KW-BR	1176	KW1	Kwikset	BR					

GM

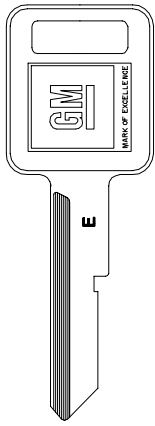

 B46G

 B48G

 B50G

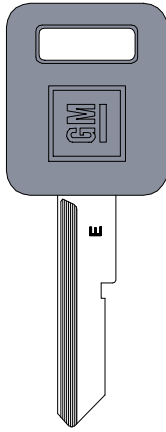

 B48GP

 B50GP

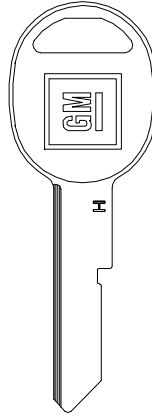

 B47G

 B49G

 B51G

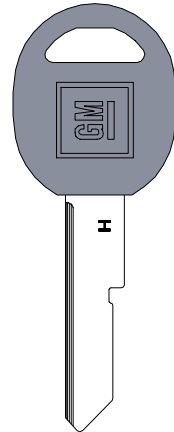

 B49GP

 B51GP



B44G



B44GP



B45G



B45GP

ILCO

GM

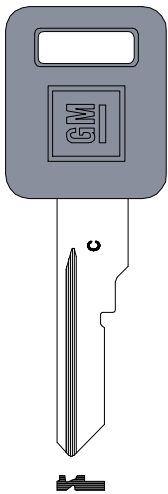

B63GP

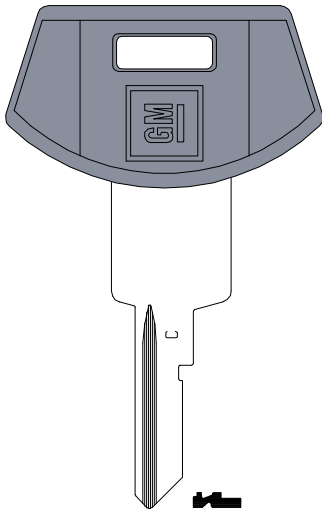

B64GP

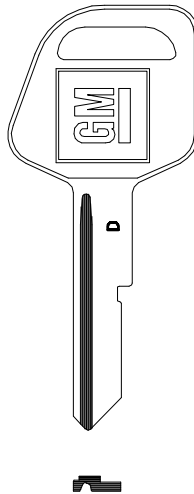

B67G

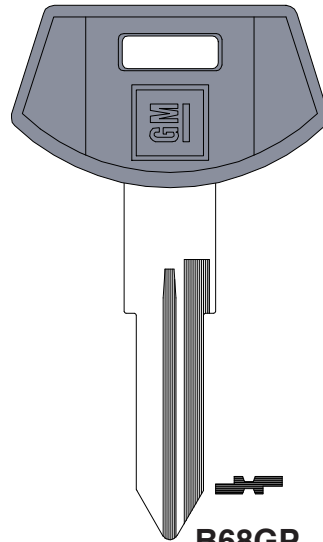

B68GP

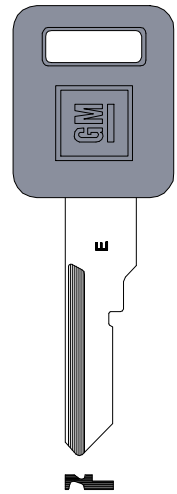

B77GP

ILCO

GM

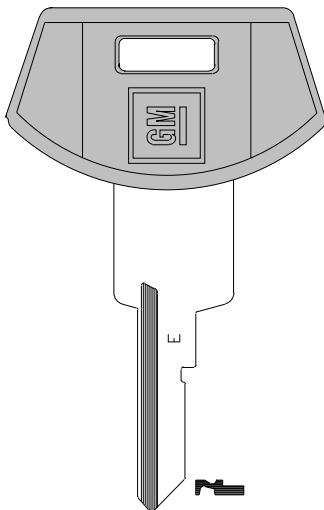

B78GP

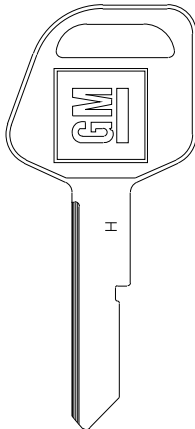

B79G

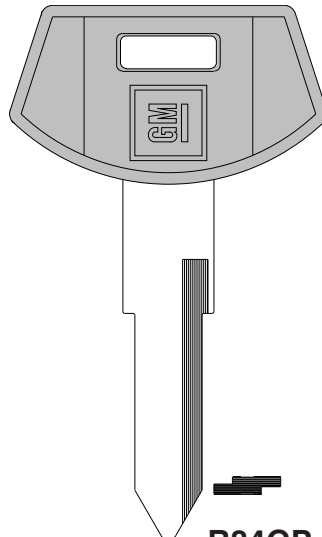

B84GP

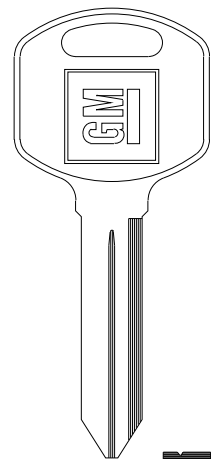

B85G

ILCO

GM

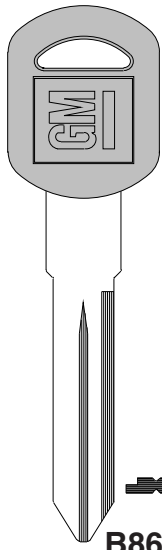

B86GP

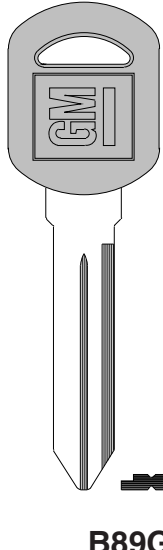

B89GP

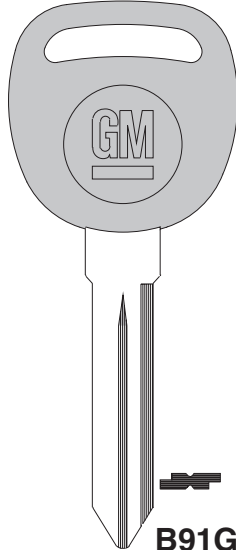

B91GP

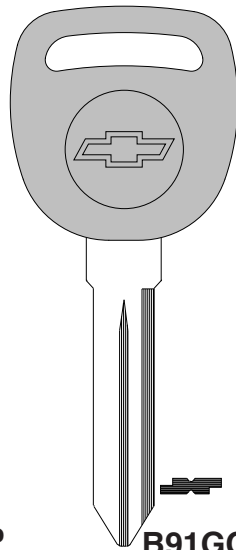

B91GCP

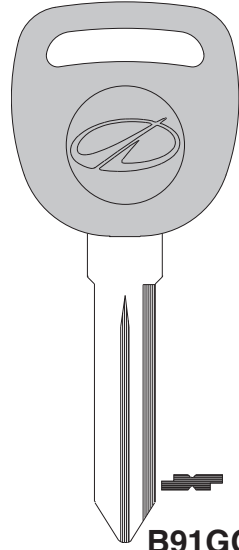

B91GOP

ILCO

GM

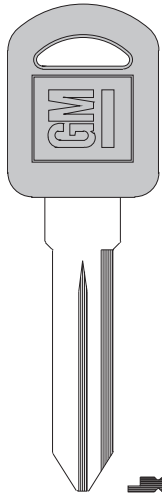

B92GP

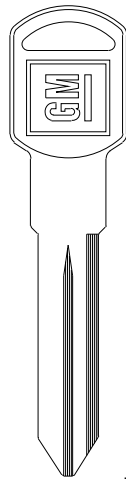

VALET FOR B92GP

B92GV

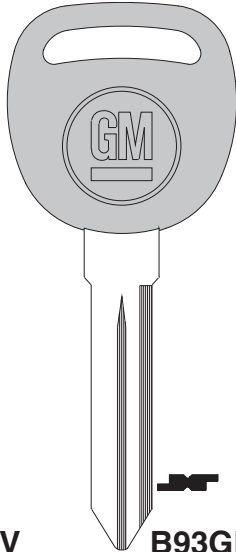

B93GP

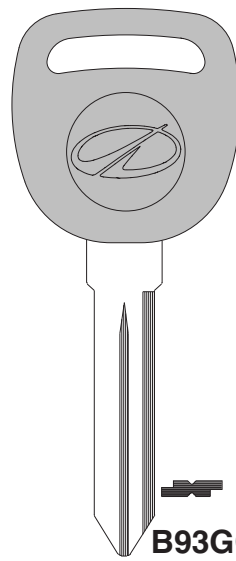

B93GOP

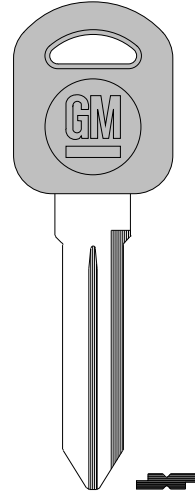

B97GPT

ILCO

GM

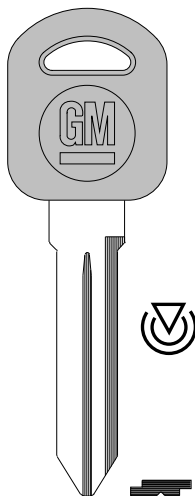

B98GPT

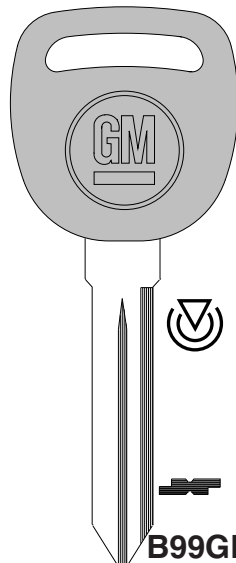

B99GPT

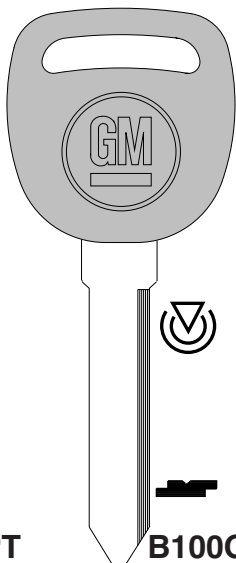

B100GPT

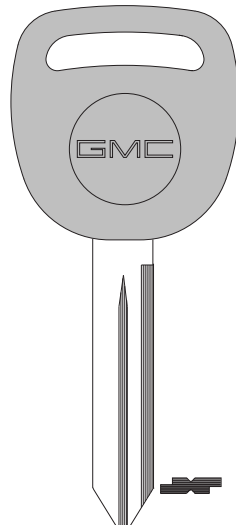

B102GP

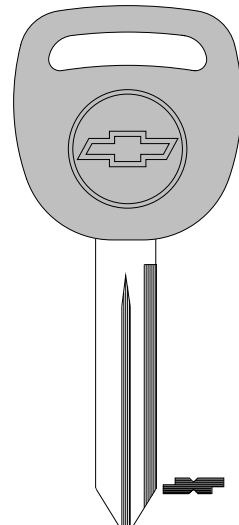

B102GCP

ILCO

GM

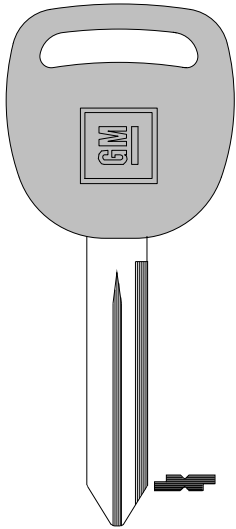

B102GMP

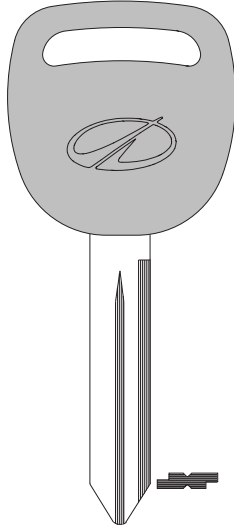

B102GOP

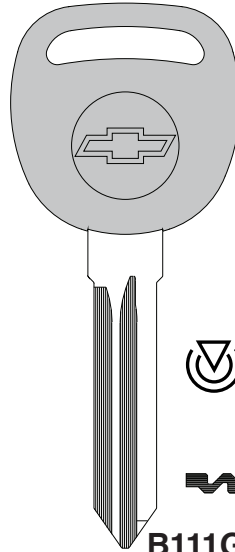

B111GCPT

ILCO

ORIGINALS

sec page
4a 3

ILCO

KWIKSET



10119-001

ILCO

AMERICAN LOCK

ARROW

BEST

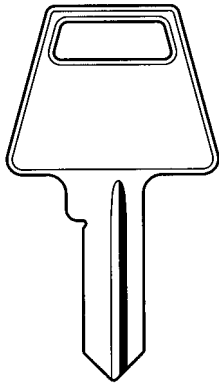

PTKB1

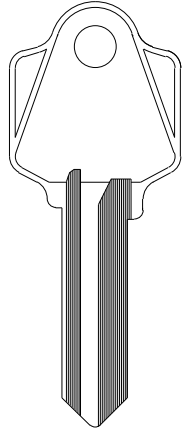

K2-A

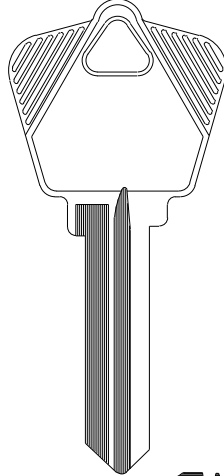

K7
NICKEL SILVER

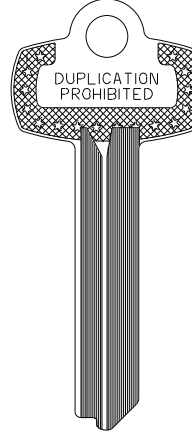

1A1A1
NICKEL SILVER

- | | | | |
|--|--------|--|--------|
| | 1A1B1 | | 1A1J1 |
| | 1A1C1 | | 1A1K1 |
| | 1A1D1 | | 1A1L1 |
| | 1A1DD1 | | 1A1M1 |
| | 1A1E1 | | 1A1Q1 |
| | 1A1F1 | | 1A1R1 |
| | 1A1G1 | | 1A1FM1 |
| | 1A1H1 | | |

Orig. No.

BEST

CHICAGO

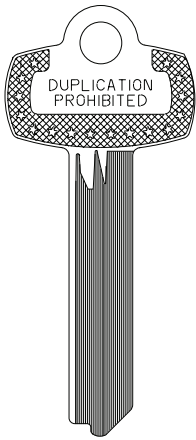

1A1T1
NICKEL SILVER

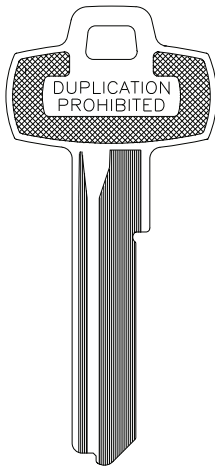

1A1WA1
NICKEL SILVER

- | | | | |
|--|--------|--|--------|
| | 1A1WB1 | | 1A1WC1 |
|--|--------|--|--------|

- | | | | |
|--|--------|--|--------|
| | 1A1WD1 | | 1A1WE1 |
|--|--------|--|--------|

- | | | | |
|--|--------|--|--------|
| | 1A1WG1 | | 1A1WH1 |
|--|--------|--|--------|

- | | |
|--|--------|
| | 1A1WY1 |
|--|--------|

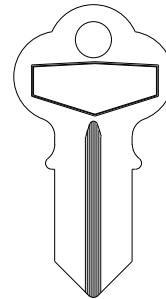

K4

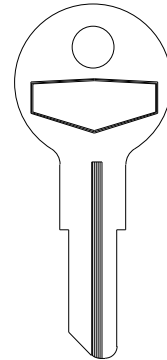

K5

Orig. No.

CORBIN (now Corbin/Russwin)

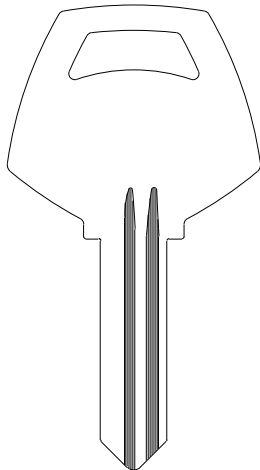

W4-59A1-6
NICKEL SILVER

- W4-59A2-6
- W4-59B1-6
- W4-59B2-6
- W4-59C1-6
- W4-59C2-6
- W4-59D1-6
- W4-59D2-6

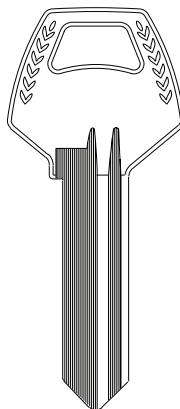

Z1-59A1-6
NICKEL SILVER

- Z1-59A2-6
- Z1-59B1-6
- Z1-59B2-6
- Z1-59C1-6
- Z1-59C2-6
- Z1-59D1-6
- Z1-59D2-6

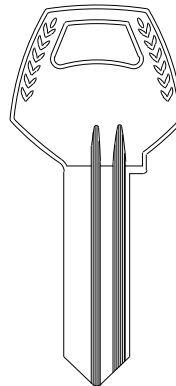

Z1-60-5
NICKEL SILVER

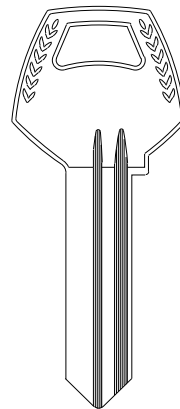

Z1-60-6
NICKEL SILVER

Orig. No.

LOOK ALIKE®

	DEXTERMMASTER	DOMINION	FALCON		HARLOC	HUDSON
Orig. No.	67	S54F	P1577E NICKEL SILVER	KB1577G NICKEL SILVER	HARLOC	H20

	HUDSON	KWIKSET			
Orig. No.	H21	1063KW	1063KW-BR	N1063KW	07743

	KWIKSET/TITAN	LOCKWOOD		MASTER	
Orig. No.	08260KW	B308	B310	1K	15K

LOOK ALIKE®

MEDECO®

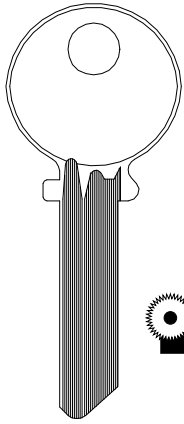

1515

NICKEL SILVER

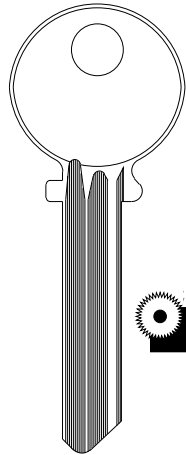

A1515

NICKEL SILVER

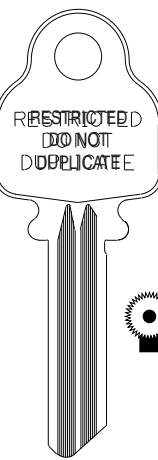

1517

NICKEL SILVER

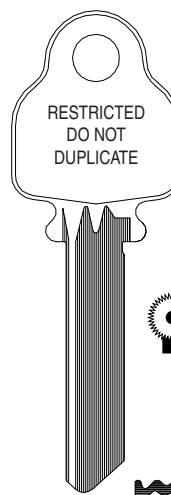

A1517

NICKEL SILVER

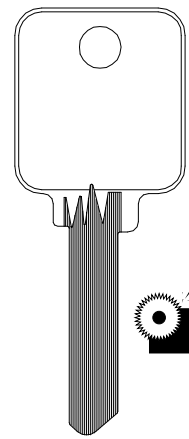

1518

NICKEL SILVER

Orig.
No.

MEDECO®

NATIONAL/AMEROCK

RUSSWIN

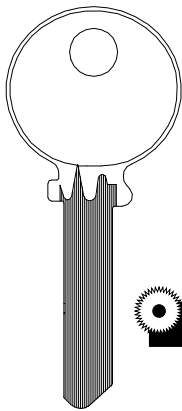

1542

NICKEL SILVER

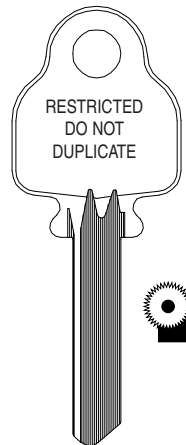

1543

NICKEL SILVER

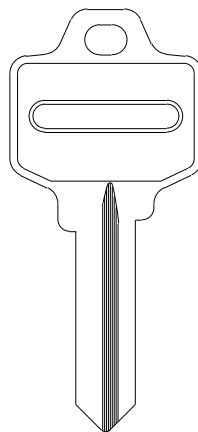

4295

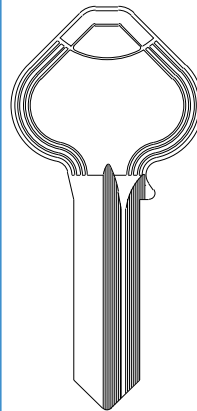

5D1R

NICKEL SILVER

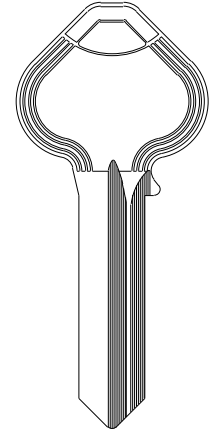

6D1R

NICKEL SILVER

Orig.
No.

SARGENT

SCHLAGE

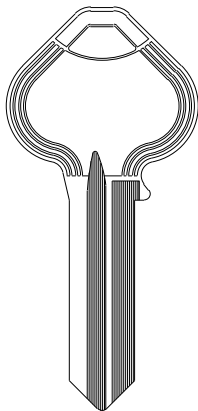

5981R

NICKEL SILVER

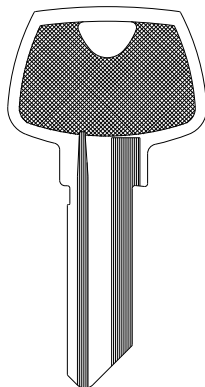

275S

NICKEL SILVER

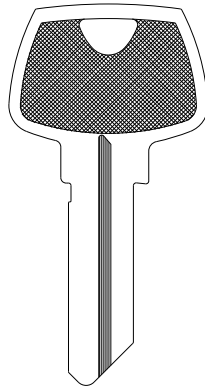

275LA

NICKEL SILVER

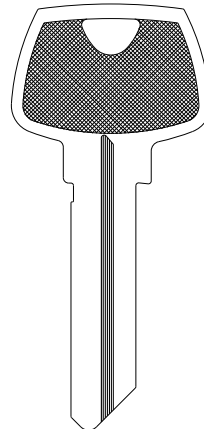

6275LA

NICKEL SILVER

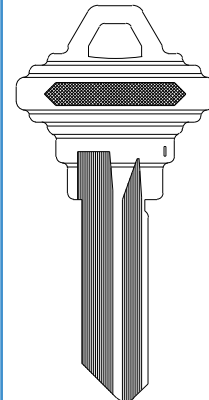

100-C

100C-NS

Orig. No.

LOOK ALIKE®

sec 4b page 3

SCHLAGE

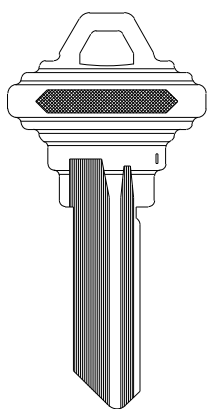

100-E
100E-NS

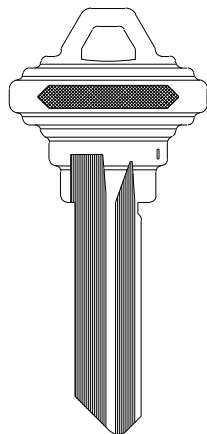

101-C
101C-NS

101E
101E-NS
 101CE-NS
 101EF-NS

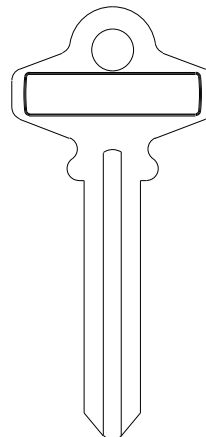

180A

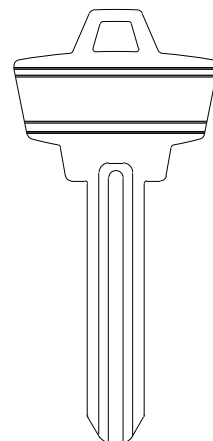

200W

Orig. No.

SEGAL

TITAN

VIRO

WEISER

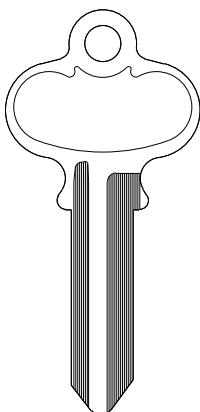

K9

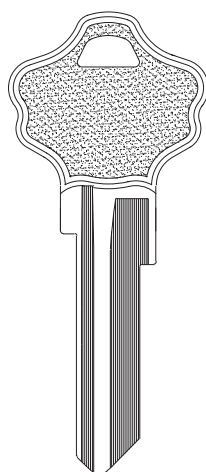

83559

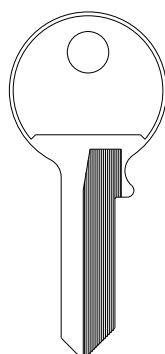

13D

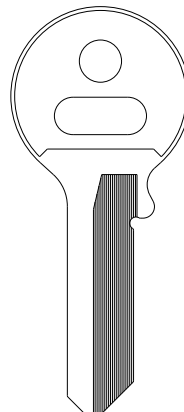

15D

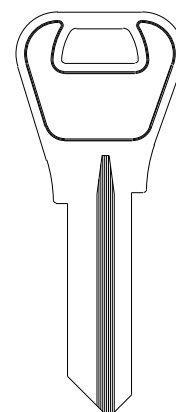

1555
1555-NS

Orig. No.

WEISER

WESLOCK

YALE

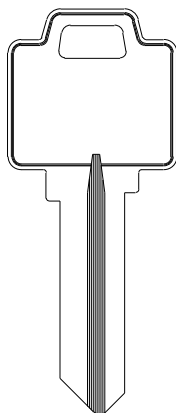

P1555
P1555-NS

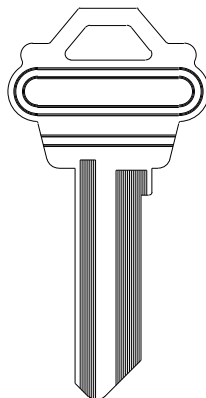

12344
12344-NS

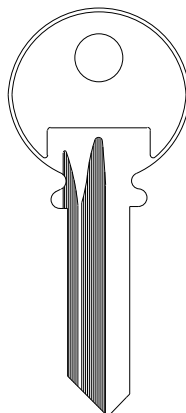

8
8-YALE-NS

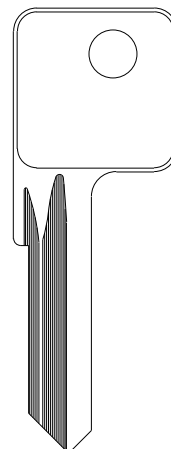

E8

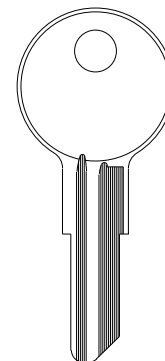

9114

Orig. No.

LOOK ALIKE®

sec page
4b 4

YALE	AMERICAN MOTORS		CHRYSLER	FORD	
9278	320560	320561	320514	320433	00113

Orig. No.

FORD		GENERAL MOTORS		
00114	00116	GM-A	GM-B	GM-C

Orig. No.

GENERAL MOTORS				
GM-D	GM-E	GM-H	GM-J	GM-K

Orig. No.

LOOK ALIKE®