

# INSTALLATION & OPERATING INSTRUCTIONS

## ELECTRONIC PANIC LOCK MODELS 250,250L,260 & 260L

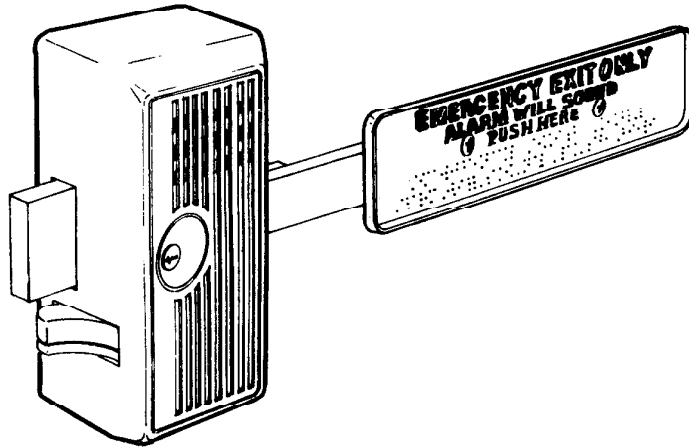

PANIC  
HARDWARE  
LISTED 198G

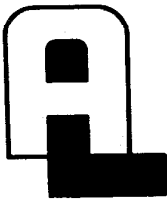

**ALARM LOCK SYSTEMS, INC.**

345 Bayview Ave. Amityville, NY 11701

**DETAIL ASSEMBLY OF 250 & 260 SERIES**

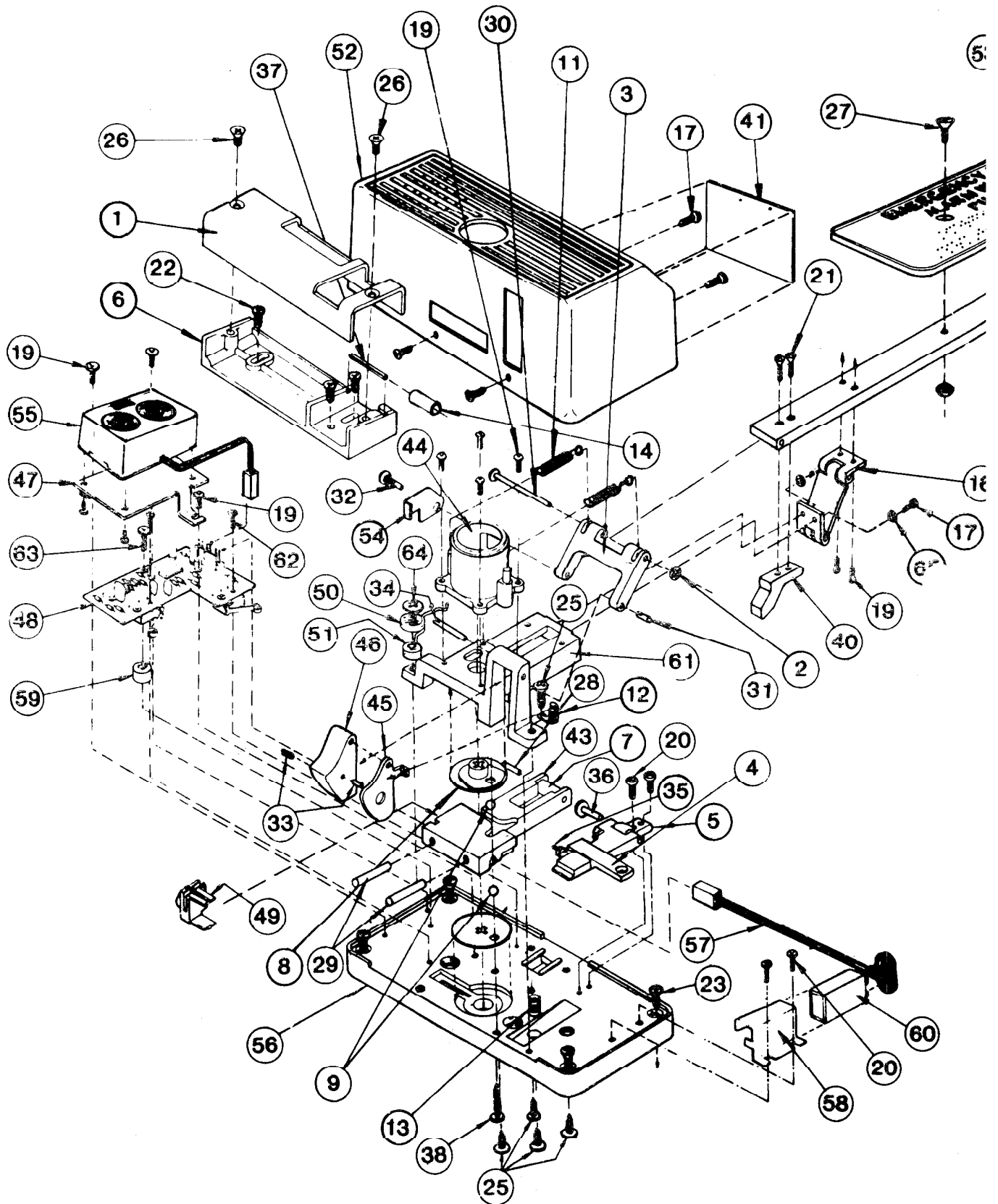

DES. 'P' NO.	DESCRIPTION	DES. 'P' NO.	DESCRIPTION
1 P0248	KEEPER COVER	33 P1932	(PART OF S5252 ASS'Y)
2 P1140	(PART OF S5251 ASS'Y)	34 P1933	(PART OF S5252 ASS'Y)
3 P1146	(PART OF S5252 ASS'Y)	35 P1934	(PART OF S3120 ASS'Y)
4 P1151	(PART OF S3120 ASS'Y)	36 P1935	(PART OF S3120 ASS'Y)
5 P1152	(PART OF S3120 ASS'Y)	37 P1937	(PART OF S3121 ASS'Y)
6 P1157	KEEPER BASE	38 P4155	10-24 X 5/8 PH PHIL.
7 P1158	(PART OF S3113 ASS'Y)	39 P4493	CLAPPER ARM
8 P1159	(PART OF S3114 ASS'Y)	40 P4495	TRIGGER CAM
9 P1160	(PART OF S3114 ASS'Y)	41 P5232	PROD.LABEL 250/260
10 P0250	KEEPER COVER *	42 P5111	LOCK COVER (DURONODIC) *
11 P1168	(PART OF S5252 ASS'Y)	43 P1143	(PART OF S3113 ASS'Y)
12 P1169	LATCH TRIP SPRING	44 P1145	(PART OF S5252 ASS'Y)
13 P1170	D'LOCK LEVER SPRING	45 P1149	(PART OF S5252 ASS'Y)
14 P1171	(PART OF S3121 ASS'Y)	46 P1150	(PART OF S5252 ASS'Y)
15 P1250	CLAPPER PLATE (LONG) *	47 P5012	PIEZO MT. PLATE
16 P1260	HINGE	48 S5227	SUB-ASS'Y PCB
17 P1508	6-32 X 1/4L TRUSS HD.	49 P5019	CAM FOLLOWER
18 P4545	CLAPPER ARM	50 P5029	TENSION SPRING
19 P1520	(PART OF S5252 ASS'Y)	51 P5030	TENSION SPRING SPACER
20 P1613	8-32 X 1/2L PH PHIL.	52 P5031	LOCK COVER (ALUM)
21 P1615	8-32 X 1/2L FH PHIL.	53 P5050	CLAPPER PLATE
22 P1675	10 X 1 1/4L PH PHIL.	54 P5054	(PART OF S5252 ASS'Y)
23 P1676	10 X 1 1/2L FH PHIL.	55 S5228	SUB-ASS'Y PIEZO SOUNDER
24 P1684	NUT 10-32 X 3/8 HEX.	56 P5063	LOCK BASE PLATE
25 P1739	10-24 X 1/2L PH PHIL.	57 S5229	SUB-ASS'Y BATT.CONT.
26 P1740	10-32 X 1/2L FH PHIL.	58 P5077	BATTERY CLAMP BKT.
27 P1748	10-32 X 3/4L OVAL HD.	59 P5089	SPACER,NYLON 1/4L
28 P1927	(PART OF S3113 ASS'Y)	60 P5103	BATTERY,9 VOLT
29 P1928	(PART OF S3113 ASS'Y)	61 P5121	(PART OF S5252 ASS'Y)
30 P1929	(PART OF S5251 ASS'Y)	62 P5195	SCRW,2-56 X 1/2L PH PHIL.
31 P1930	(PART OF S5252 ASS'Y)	63 P5194	SCRW,4-40 X 1/2L PH PHIL.
32 P1931	(PART OF S5252 ASS'Y)	64 P5197	SCRW,10-24 X 3/4L HEX SLOT
		65 P5244	INTERNAL TOOTH LOCKWASHER

\*-OPTIONAL PARTS AVAILABLE .CONTACT YOUR SALES REP. FOR MORE INFORMATION.

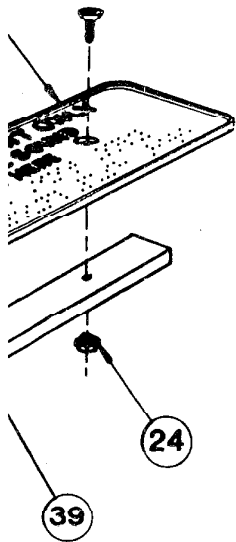

### SPECIFICATIONS:

**DIMENSIONS:** Model 250 / 260 18"W X 8 1/2"H X 3 1/4"D  
 Model 250L / 260L 24"W X 8 1/2"H X 3 1/4"D

**WEIGHT:** 9 lbs. approx.

**SHIP/WEIGHT:** 10 lbs. approx.

**FINISH:** US28 aluminum baked enamel  
 US312E duranodic

**POWER:** 9VDC alkaline battery

**CURRENT:** standby - 7 micro amps typ.  
 alarm - 75 milli amps typ.

**BATTERY LIFE:** one year standby typ.  
 200 alarm sequences typ.  
 or constant alarm for 7 hours typ.

**LOW BATTERY DETECTION:** short beep from piezo horn - 1 per minute typ.

**AUTO ALARM SHUTDOWN:** 2 minutes typ.

**SOUND PRESSURE LEVEL:** dual piezo horn 95db measured at 10 feet

**OPERATING TEMPERATURE:** 20 deg. F to 135 deg. F  
 (-7 deg. C to 57 deg. C)

**NOTE:** all above specifications rated at 72 deg. F  
 (22 deg. C)

## OPERATING INSTRUCTIONS

### BEFORE INSTALLING THE LOCK COVER:

- 1) Select - For continuous alarm, leave the black jumper plug on the terminal strip, as installed  
- For two minute auto-alarm shutdown, remove the black jumper plug from the terminal strip.
- 2) Connect the battery connector to the 9 volt battery observing the proper polarity. A short beep will sound ensuring that the lock is powered and ready.
- 3) Install the lock cover with four (4) screws supplied.
- 4) Close the door.

## OPERATIONAL TESTING

- 1) Lock and unlock the door using the cylinder key and note a small beep will sound when the deadbolt is retracted, indicating a disarmed condition. The door can now be opened without an alarm, by pushing the clapper plate.
- 2) Lock the door again and push the clapper plate to open it. Immediately the alarm will pulse loudly and one of the following will occur:
  - A) If continuous alarm has previously been selected the alarm will sound until the lock is manually reset by locking the deadbolt with the key.
  - B) If auto-alarm shutdown has been selected the alarm will sound for two minutes then reset.

## LOW BATTERY DETECTION

When the battery becomes weak, the sounder will emit a short beep approximately once a minute indicating the battery needs replacing.

## RETRIGGERABLE OPERATION

If the unit has a retriggerable alarm (Model 260), after the initial two minute alarm and auto shutdown, the alarm will retrigger if the door is opened again. This function will remain retriggerable until the door is relocked with the key.

**NOTE:** Whenever an alarm is caused by opening the door, and the door is left open, the two minute alarm shutdown will be inhibited.

# ALARM LOCK LIMITED WARRANTY

**ALARM LOCK SYSTEMS, INC.** warrants each of its products to be free from manufacturing defects in materials and workmanship for fifteen months following the date of manufacture. **ALARM LOCK** will, within said period, at its option, repair or replace any product failing to operate correctly, without charge to the original purchaser or user.

This warranty shall not apply to any equipment or any part thereof which has been repaired by others, improperly installed, improperly used, abused, altered, damaged, subjected to accident, nuisance, flood, fire or acts of God, or on which any serial numbers have been altered, defaced or removed. Seller will not be responsible for any dismantling, reassembly or reinstallation charges.

In order to exercise the warranty, the product must be returned by the user or purchaser, shipping costs prepaid, and insured to **ALARM LOCK**. After repair or replacement, **ALARM LOCK** assumes the cost of returning products under warranty.

*There are no warranties, express or implied which extend beyond the description on the face hereof. There is no express or implied warranty of merchantability or a warranty of fitness for a particular purpose. Additionally, this warranty is in lieu of all other obligations or liabilities on the part of **ALARM LOCK**.*

*This warranty contains the entire warranty. It is the sole warranty and any prior agreements, or, representations, whether oral or written, are either merged herein or are expressly cancelled. **ALARM LOCK** neither assumes, nor authorizes any other person purporting to act on its behalf to modify, to change, nor to assume for it, any other warranty or liability concerning its products.*

In no event shall **ALARM LOCK** be liable for an amount in excess of **ALARM LOCK's** original selling price of the product, for any commercial loss or damage, whether direct, indirect, incidental, consequential, or otherwise arising out of any failure of the product. Seller's warranty, as hereinabove set forth, shall not be enlarged, diminished or affected by and no obligation or liability shall arise or grow out of Seller's rendering of technical advice or service in connection with Buyer's order of the goods furnished hereunder.

Warning: Despite frequent testing, and due to, but not limited to, any or all of the following: criminal tampering, electrical or communications disruption, it is possible for the system to fail to perform as expected. Therefore, the consumer is advised to take any and all precautions for his or her safety including, but not limited to, fleeing the premises and calling police or fire department, in order to mitigate the possibilities of harm and/or damage.

This warranty shall be construed in accordance with the laws of the State of New Jersey.



# INSTALLATION & OPERATING INSTRUCTIONS

## ELECTRONIC PANIC LOCK MODELS 250,250L,260 & 260L

### INSTALLATION

- 1) With the door closed, select the proper template and tape it to the inside face of the door with the center line approximately 38" above the floor per template directions.
- 2) Mark and drill the following holes (see template for details):
  - A) **FOR SINGLE AND DOUBLE DOORS:** Mark six (6) .157" dia. holes, four (4) for the lock mounting plate and two (2) for the keeper.
  - B) Mark a 1/4" dia hole for the rub plate on double doors 1 3/4" thick only.
  - C) **IF OUTSIDE CYLINDER (CER-OKC) IS USED:** mark the center of the 1/4" dia. hole.
  - D) **IF OUTSIDE PULL MODEL 707 IS USED:** mark the center of the four (4) 1/4" dia. holes.
  - E) If mounting the lock on a hollow metal door and wires are to be run through the door, drill hole x (see template).  
**NOTE:** If outside pull is used, drill four (4) holes 1/4" dia. through the door from the inside. Then drill 3/4" dia. holes 1 1/4" deep from the outside of the door.
- 3) Remove the lock cover and four (4) screws holding the cylinder housing to the bolt cover. Install rim cylinder (CER) with the keyway horizontal, facing the front of the lock (nine o'clock position) and cut the cylinder tailpiece 3/8" beyond the base of the cylinder. Reinstall the cylinder housing, guiding the tailpiece into the crosshole of the cam with four (4) screws.
- 4) Use the key to test for proper operation of the deadbolt. The key should be able to be withdrawn from the lock in either the fully locked or fully unlocked position of the deadbolt. If not, the cylinder and the cam are mis-aligned and the cylinder housing must be removed. Turn the cam a quarter (1/4) turn to the right, and reinstall the cylinder housing. (**NOTE:** the deadbolt can be projected into the keeper by turning the key counter-clockwise and can be withdrawn from the keeper by turning the key clockwise one full turn.)
- 5) **FOR OUTSIDE CYLINDER ONLY (CER-OKC):** Install the rim cylinder with the keyway horizontal facing the front of the door (three o'clock position) with the screws supplied and cut the tailpiece 3/8" beyond the inside face of the door.
- 6) **FOR OUTSIDE CYLINDER ONLY:** Guide the tailpiece of the outside cylinder into the crosshole of the outside cam.
- 7) Install the lock to the door with four (4) #10 screws as supplied.
- 8) **FOR SINGLE DOOR ONLY:** Remove the keeper cover, roller, and pin. Install the keeper base on the door with two (2) screws supplied. Reinstall the pin, roller and cover with two screws.  
**FOR DOUBLE DOOR ONLY:** Install the rub plate for a 1 3/4" wide door, from inside the door. Also install the 732 keeper with two (2) #10 screws supplied. Do not tighten the screws fully because the keeper will require adjustment as mentioned in instruction 9.
- 9) **FOR SINGLE DOOR ONLY:** Close the door, project the deadbolt and adjust the keeper so that the door is tightly latched. Retract the deadbolt, hold the keeper, release the latch and open the door. Open the keeper cover and tighten the screws. Drill a .157" dia. hole, as shown on template, for the holding screw, and fasten the keeper with a #10 screw. Reinstall pin, roller and cover with two screws.  
**FOR DOUBLE DOOR ONLY:** Close the door, project the bolt and adjust the plastic slide on the 732 keeper so the door is tightly latched and tighten the screws.

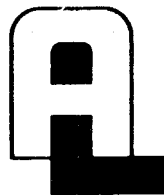

**ALARM LOCK**

## Installation:

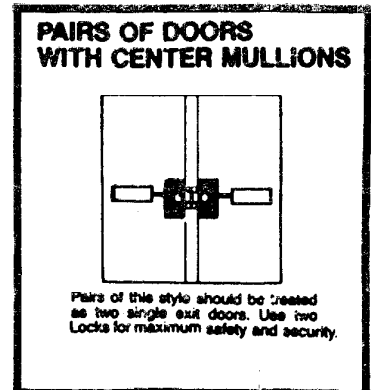
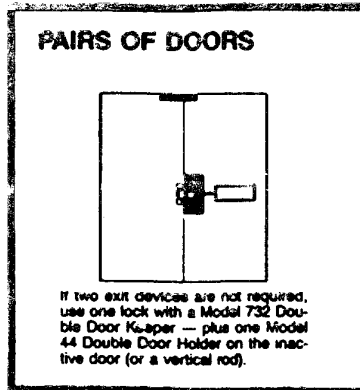
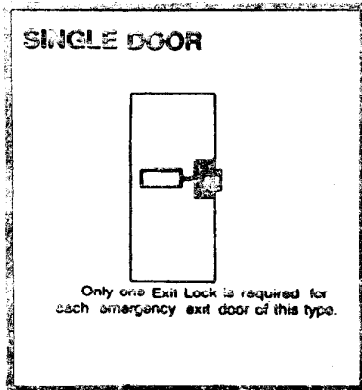

## ELECTRONIC PANIC LOCK ACCESSORIES:

### FINISH BACK PLATE MODEL 767

Required to conceal the open back of the lock body when mounted on a glass door. Stainless Steel 4 1/2" x 8 1/2".



### DOUBLE DOOR KEEPER MODEL 732

Applied to the surface of the inactive leaf of a pair of doors. Plated Case Aluminum - 7/8" x 6"

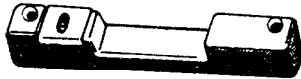

### ARMORED DOOR LOOP MODEL 271

For use with Electrified locks. An easy means for bringing electric current from the hinge side of a door frame to the door. 18" flexible armored cable. End brackets are deep drawn anodized aluminum to conceal wire connections.



### DOUBLE DOOR HOLDER MODEL 44

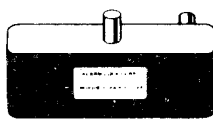

The Double Door Holder secures the inactive door to the door frame while the active door is closed. Releasing the active door automatically allows both doors to swing freely. Reversible, right or left hand doors. Cast aluminum 8 1/2" long, 3" wide, and 2 1/2" high.

### BATTERY ELIMINATOR - MODEL AC-9

The AC-9 battery eliminator provides constant regulated 9VDC power for Models 250 and 260. It is simple to install and maintenance free. 117 VAC to 9VDC. The AC-9 conserves the battery which automatically takes over as the power source in the event of a power failure or intentional power cutoff.

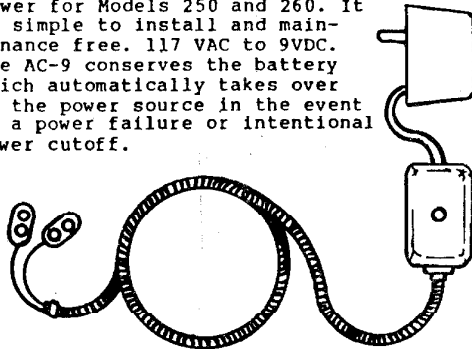

### THUMB TURN MODEL THT

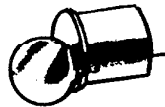

Used instead of cylinder and keys to retract and project the deadbolt from inside.

### OUTSIDE ACCESS DOOR PULL MODEL 707

For access from building exteriors. Installed on the outside of the door and linked to the lock. After deadbolt is retracted by outside key, a slight pull will release the deadlatch and open door. Cast aluminum — 8" x 1 1/2"



### SINGLE DOOR KEEPER MODEL 730

Supplied for single doors or pairs of doors with mullions.



### CYLINDER FINGER PULL MODEL 711



An inexpensive door pull for use when outside key only access is required.

### RIM CYLINDER MODEL CER-OKK

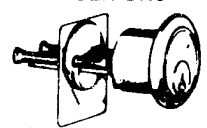

Used to lock and unlock all our exit and panic alarm locks from outside. Includes two keys for outside key control (KA or KD).

### LATCH HOLDBACK DEVICE MODEL 747

An integral lock modification which "dogs" the latchbolt to provide a hold-open function. Simply depress the latchbolt beyond the face of the lock and it will remain retracted until the door is relocked by key.

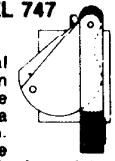

### STANDARD FEATURES FOR 250 & 260 SERIES

- UNIT IS NON-HANDED
- DEADBOLT WITH HARDENED STEEL INSERT
- DEADLATCH FOR EASY ACCESS FROM INSIDE WITHOUT ALARM
- DEADBOLT CAN BE OPERATED BY OUTSIDE KEY
- LOCK ONLY REQUIRES 5 TO 10 LBS. OF FORCE TO OPERATE
- CAN BE USED FOR SINGLE OR DOUBLE DOORS
- LOUD DUAL PIEZO HORN
- SELECTABLE - CONTINUOUS OR TWO MIN. ALARM SHUTDOWN
- DISARMING BEEP WHEN BOLT IS RETRACTED WITH KEY
- LOW BATTERY BEEP WHEN BATTERY NEEDS TO BE REPLACED
- RETRIGGERABLE ALARM AFTER TWO MIN. SHUTDOWN FOR MODEL 260 ONLY